



USER MANUAL

**Elo Touch Solutions**  
**1528L Touchmonitors**

SW2000095 Rev A



**Copyright 2012 Elo Touch Solutions, Inc. All Rights Reserved.**

No part of this publication may be reproduced, transmitted, transcribed, stored in a retrieval system, or translated into any language or computer language, in any form or by any means, including, but not limited to, electronic, magnetic, optical, chemical, manual, or otherwise without prior written permission of Elo Touch Solutions, Inc.

### **Disclaimer**

The information in this document is subject to change without notice. Elo Touch Solutions, Inc. makes no representations or warranties with respect to the contents hereof, and specifically disclaims any implied warranties of merchantability or fitness for a particular purpose. Elo Touch Solutions, Inc. reserves the right to revise this publication and to make changes from time to time in the content hereof without obligation of Elo Touch Solutions, Inc. to notify any person of such revisions or changes.

### **Trademark Acknowledgments**

AccuTouch, CarrollTouch, Elo Touch Solutions, Elo TouchSystems, IntelliTouch, SecureTouch, and TouchTools are trademarks. Other product names mentioned herein may be trademarks or registered trademarks of their respective companies.

# Warnings and Cautions

---



## Warning

- Danger — Explosion hazard. Do not use in the presence of flammable anesthetics.
- To prevent fire or shock hazards, do not immerse the unit in water or expose it to rain or moisture.
- Do not use the unit with an extension cord receptacle or other outlets unless the prongs of the power cord can be fully inserted.
- RISK OF ELECTRICAL SHOCK — DO NOT OPEN. To reduce the risk of electrical shock, DO NOT remove the back of the equipment or open the enclosure. No user-serviceable parts are inside. Refer servicing to qualified field service engineers only.
- Uninsulated voltage within the unit may have sufficient magnitude to cause electrical shock. Avoid contact with any part inside the unit.

## Caution

- Before connecting the cables to your Elo TouchSystems touchmonitor, make sure all components are powered OFF.
- The use of ACCESSORY equipment not complying with the equivalent safety requirements of this equipment may lead to a reduced safety of the resulting system. Consideration relating to the choices of accessory equipment should include:
  - Use of accessory in the patient vicinity.
  - Evidence that the safety certification of the accessory has been performed in accordance to the appropriate IEC 60601-1 and/or IEC 60601-1-1 harmonized national standard.
- For continued safety —
  - This unit only complies to the above standards if used with a medical grade power cord.
  - A medical grade power adaptor, such as the one specified, is required for use in a medical application.



### **CAUTION-Life Support**

Care must be taken when this touchmonitor is a critical component of a Life support system or device. In case of failure of this touchmonitor, appropriate redundant systems should be incorporated into the system or device to prevent injury to the user or patient.

The following should be an integral part of the safety design of a Life support system or device using this touchmonitor for a critical function.

- An Alternate interface or fail-safe must be available should the touchscreen fail to operate.
- The touchscreen interface must not be the only means of control of a critical function.
- An Alternate video monitor should be incorporated into the safety design if used to monitor a critical function.
- The internal speakers of this touchmonitor must not be the sole method of warning of a critical function.

### **Critical functions are:**

1. Life support devices or systems are devices or systems which, (a) are intended for surgical implant into the body, or (b) support or sustain life, or (c) whose failure to perform when properly used in accordance with instructions for use provided in the labeling, can be reasonably expected to result in significant injury to the user.
2. A critical component is any component of a life support device or system whose failure to perform can be reasonably expected to cause the failure of the life support device or system, or to affect its safety or effectiveness.

# Classification

---



With respect to electrical shock, fire in accordance with ANSI/AAMI ES60601-1 and CAN/CSA C22.2 No. 60601-1-08

This monitor is a CLASS 1 (GROUNDED) DEVICE.

This monitor is classified NO APPLIED PARTS EQUIPMENT.

Protection against harmful ingress of water:

INGRESS PROTECTION (IPX1)

This monitor shall be classified as ORDINARY EQUIPMENT, not intended or evaluated for use in the presence of flammable anesthetic mixture with air, oxygen, or nitrous oxide.





Mode of Operation: CONTINUOUS OPERATION.

## Environmental conditions for transport and storage

Temp. Operating	0°C to 40°C
Storage	-20°C to +60°C
Humidity (non-condensing)	
Operating	20% to 80%
Storage	5% to 90%
Altitude	0 to + 3658m [12000 ft.]. Equiv. to 14.7 to 10.1 psia.
Operating	
Storage	0 to + 12 192m [40 000 ft.]. Equiv. to 14.7 to 4.4 psia.

***For full Product Specifications refer to Chapter 7.***

## Explanation of Symbols

Symbol	Description
	UL Classification means that UL has tested and evaluated samples of the product with respect to certain properties of the product. (look on page 9 )
	For those EU Directives that permit it, the CE mark indicates product compliance with standards indicated in the "Certificate of Conformance" which accompanies the product packing information. The Directive may or may not require verification by a Notified Body. The LVD, EMC and MDD Directives permit products to indicate conformity by the CE mark. MDD products may also require a Notified Body mark.
	Indicates tested to comply with FCC standards.
	Indicates compliance with the European Community WEEE directive 2002/96/EC. Dispose of according to federal, state or local regulations.
	This symbol alerts the user to consult accompanying documents for important information concerning the operation and maintenance of this unit, which should be read carefully to avoid problems.

## EMC Guidance

Guidance and manufacturer's declaration – electromagnetic emissions		
The 1528L is intended for use in the electromagnetic environment specified below. The customer or the user of the 1528L should assure that it is used in such an environment.		
Emissions test	Compliance	Electromagnetic environment – guidance
RF emissions CISPR 11	Group 1	The 1528L uses RF energy only for its internal function. Therefore, its RF emissions are very low and are not likely to cause any interference in nearby electronic equipment.
RF emissions	Class B	
Harmonic emissions IEC61000-3-2	Not applicable	
Voltage fluctuations/ flicker emissions IEC61000-3-3	Complies	

## Guidance and manufacturer's declaration – electromagnetic immunity

The 1528L is intended for use in the electromagnetic environment specified below. The customer or the user of the 1528L should assure that it is used in such an environment.

Immunity test	IEC60601 test level	Compliance level	Electromagnetic environment – guidance
Electrostatic discharge (ESD) IEC61000-4-2	±6 kV Contact ±8 kV air	±6 kV Contact ±8 kV air	Floors should be wood, concrete or ceramic tile. If floors are covered with synthetic material the relative humidity should be at least 30 %
Electrical fast transient/burst IEC61000-4-4	±2 kV for power supply lines ±1 kV for input/output lines	±2 kV for power supply lines ±1 kV for input/output lines	Main power quality should be that of a typical commercial or hospital environment.
Surge IEC6100-4-5	±1 kV differential mode ±2 kV common mode	±1 kV differential mode ±2 kV common mode	Main power quality should be that of a typical commercial or hospital environment.
Voltage dips, short interruptions and voltage variations on the power supply input lines IEC61000-4-11	<5 % $U_T$ (>95 % dip in $U_T$ ) for 0,5 cycle  40 % $U_T$ (60 % dip in $U_T$ ) for 5 cycles  70 % $U_T$ (30 % dip in $U_T$ ) for 25 cycles  <5 % $U_T$ (>95 % dip in $U_T$ ) for 5 sec	<5 % $U_T$ (>95 % dip in $U_T$ ) for 0,5 cycle  40 % $U_T$ (60 % dip in $U_T$ ) for 5 cycles  70 % $U_T$ (30 % dip in $U_T$ ) for 25 cycles  <5 % $U_T$ (>95 % dip in $U_T$ ) for 5 sec	Main power quality should be that of a typical commercial or hospital environment. If the user of the 1528L requires continued operation during power mains interruptions, it is recommended that the 1528L be powered from an uninterruptible power supply or a battery.
Power frequency (50/60 Hz) Magnetic field IEC61000-4-8	3 A/m	3 A/m, 30 A/m	Power frequency magnetic fields should be at levels characteristic of a typical location in a typical commercial or hospital environment.

NOTE  $U_T$  is the ac. mains voltage prior to application of the test level.

## Guidance and manufacture's declaration – electromagnetic immunity

The 1528L is intended for use in the electromagnetic environment specified below. The customer or the user of the 1528L should assure that it is used in such an environment.

Immunity Test	IEC60601 test level	Compliance level	Electromagnetic environment – guidance
Conducted RF IEC61000-4-6	3 Vrms 150 kHz to 80 MHz	3 V	<p>Portable and mobile RF communications equipment should be used no closer to any part of the [EQUIPMENT or SYSTEM], including cables, than the recommended separation distance calculated from the equation applicable to the frequency of the transmitter. Recommended separation distance</p> $d = 1,2 \sqrt{P}$
Radiated RF IEC61000-4-3	10 Vrms 80 MHz to 2.5 GHz	3 V/m	<p><math>d = 1,2 \sqrt{P}</math> 80 MHz to 800 MHz</p> <p><math>d = 2,3 \sqrt{P}</math> 800 MHz to 2,5 GHz</p> <p>where <math>P</math> is the maximum output power rating of the transmitter in watts (<math>W</math>) according to the transmitter manufacturer and <math>d</math> is the recommended separation distance in meters (m).<sup>b</sup></p> <p>Field strengths from fixed RF transmitters, as determined by an electromagnetic site survey,<sup>c</sup> should be less than the compliance level in each frequency range.<sup>d</sup></p> <p>Interference may occur in the vicinity of equipment marked with the following symbol:</p> 

NOTE 1 At 80 MHz and 800 MHz, the higher frequency range applies.

NOTE 2 These guidelines may not apply in all situations. Electromagnetic propagation is affected by absorption and reflection from structures, objects and people.

<sup>a</sup> The ISM (industrial, scientific, and medical) bands between 150 kHz and 80 MHz are 6,765 MHz to 6,795 MHz; 13,553 MHz to 13,567 MHz; 26,957 MHz to 27,283 MHz; and 40,66 MHz to 40,70 MHz.

<sup>b</sup> The compliance levels in the ISM frequency bands between 150 kHz and 80 MHz and the frequency range 80 MHz to 2,5 GHz are intended to decrease the likelihood that mobile/portable communications equipment could cause interference if it is inadvertently brought into patient areas. For this reason, an additional factor of 10/3 is used in calculating the recommended separation distance for transmitters in these frequency ranges.

<sup>c</sup> Field strengths from fixed transmitters, such as base stations for radio (cellular/cordless) telephones and land mobile radios, amateur radio, AM and FM radio broadcast cannot be predicted theoretically with accuracy. To assess the electromagnetic environment due to fixed RF transmitters, an electromagnetic site survey should be considered. If the measured field strength in the location in which the 1528L is used exceeds the applicable RF compliance level above, the 1528L should be observed to verify normal operation. If abnormal performance is observed, additional measures may be necessary, such as reorienting or relocating the [EQUIPMENT or SYSTEM].

<sup>d</sup> Over the frequency range 150 kHz to 80 MHz, field strengths should be less than [V1] V/m.



**Recommended separation distances between  
Portable and mobile RF communications equipment and the 1528L**

The 1528L is intended for use in which radiated RF disturbances are controlled. The customer or the user of the 1528L can help prevent electromagnetic interference by maintaining a minimum distance between portable and mobile RF communications equipment (transmitters) and the 1528L as recommended below, according to the maximum output power of the communications equipment.

Rated maximum output power of transmitter W	Separation distance according to frequency of transmitter M		
	150 kHz to 80 MHz $d = 1,2 \sqrt{P}$	80 MHz to 800 MHz $d = 1,2 \sqrt{P}$	800 MHz to 2,5 GHz $d = 2,3 \sqrt{P}$
0,01	0,12	0,12	0,23
0.1	0,38	0,38	0.73
1	1,2	1,2	2,3
10	3,8	3,8	7,3
100	12	12	23

For transmitters rated at a maximum output power not listed above, the recommended separation distance d in meters (m) can be estimated using the equation applicable to frequency of the transmitter, where P is the maximum output power rating of the transmitter in watts (W) according to the transmitter manufacturer.

NOTE 1 At 80 MHz and 800 MHz, the separation distance for the higher frequency range applies.

NOTE 2 These guidelines may not apply in all situations. Electromagnetic propagation is affected by absorption and reflection from structures, objects and people.

This device complies with all applicable electromagnetic emission and immunity standards for medical device equipment. This device is designed to not cause harmful interference, and to accept any interference received, including interference that may cause undesired operation. The performance of this device is limited to the emission and immunity standards that have been applied. Other devices which are not designed to withstand emission levels as specified in the medical device standards may be susceptible to interference from this device. Subjecting the device to conditions beyond the rated performance capabilities may result in emissions in excess of the standard. If it is determined that this device produces electromagnetic or other interference it must be disconnected from power until the cause of the problem has been determined and resolved. If it is determined that this device is functioning improperly due to electromagnetic and other interference it must be disconnected from power until the cause of the problem has been determined and resolved.

# Table of Contents

- Chapter 1: Introduction..... 11**
- Chapter 1: Introduction..... 11**
- Chapter 2: Installation and Setup ..... 12**
- Chapter 3: Operation..... 19**
- Chapter 4: Troubleshooting ..... 23**
- Chapter 5: Native Resolution ..... 24**
- Chapter 6: Touchmonitor Safety..... 25**
- Chapter 7: Technical Specifications..... 27**
- Chapter 8: Contact Elo Touch Solutions ..... 35**
- Chapter 9: Regulatory Information ..... 36**
- Chapter 10: Warranty ..... 38**

# Chapter 1: Introduction

## Product Description

---

The 1528L is a medical 15-inch touchmonitor which uses liquid crystal monitor (LCD) technology, designed to present information to the operator, care-giver and the patient. The 1528L features both serial and USB touch interfaces as standard configuration. The 1528L functionally consists of a 15-inch LCD main monitor with a touchscreen. The monitor element is a 15.0 inch diagonal XGA resolution (1024x768) LCD monitor. Three types of touchscreen technology are offered for the 1528L as standard options: AccuTouch technology (resistive), IntelliTouch technology, Surface Acoustic Wave (SAW), and CarrollTouch technology (Infrared /IR/). The 1528L is powered by 12 VDC from an external medical grade power adapter.

## LCD Monitor Performance Features

---

### 15 inch TFT LCD Monitor Panel

Monitor format	1024x768
Monitor area	304.1 mm (H) x 228 mm (V)
Pixel pitch	0.297 mm (H) x 0.297 mm (V)
Contrast ratio	400:1 typical
Brightness	
LCD	350 cd/m <sup>2</sup> (Typical)
AccuTouch technology	287 cd/m <sup>2</sup> (Typical)
IntelliTouch technology	322 cd/m <sup>2</sup> (Typical)
CarrollTouch technology	322 cd/m <sup>2</sup> (Typical)
AccuTouch transmission	82% typical
IntelliTouch transmission	92% typical
IR Touchscreen transmission	92% typical
Response time	Tr = 12 msec / Tf = 16 msec typical
Monitor color	16.2 million colors, 6 Bit with dithering
Typical vertical viewing angle:	60 deg (looking down) / 40 deg (looking up)
Typical horizontal viewing angle:	60 deg (looking left) / 60 deg (looking right)

### External Medical Grade Power Adapter

The 1528L is powered by an external medical grade universal input power adapter.

Power adapter:

- AC power: Input voltage 100 - 240 Vac
- Input frequency 50 / 60 Hz
- DC output: 12 Vdc
- Line and load regulation:  $\pm 3\%$

# Chapter 2: Installation and Setup

This chapter discusses how to install your LCD touchmonitor and how to install Elo TouchSystems driver software.

## Unpacking Your Touchmonitor

Check that the following items are present and in good condition:

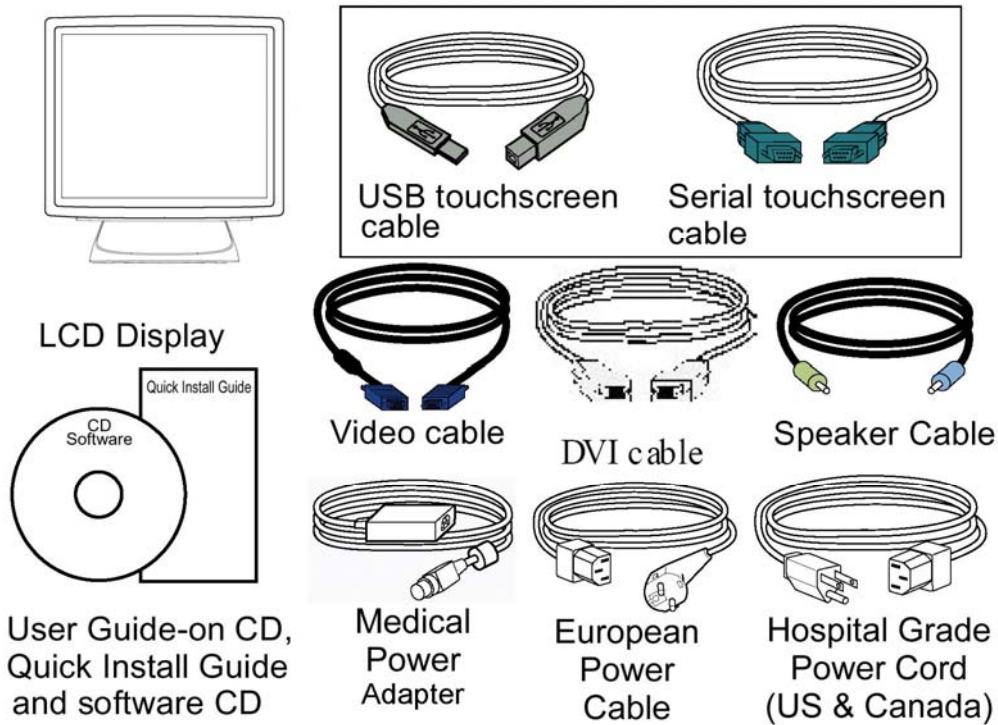

# Product Overview

---

## Front View



## Rear View



## Side View



## Kensington™ Lock

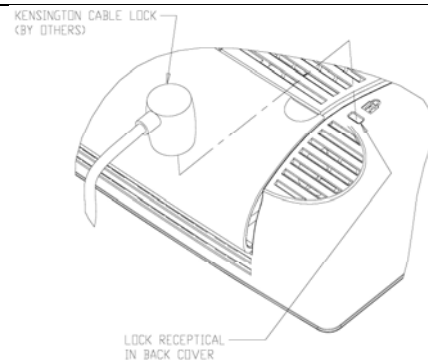

The Kensington™ lock is a security device that prevents theft. To find out more about this security device, go to <http://www.kensington.com>.

# USB Interface Connection

---

Your touchmonitor comes with one **USB** cable. (For use with Windows 2000, ME, and XP systems only.)

To set up the monitor, please refer to the following figures and procedures:

## Remove the Cable Cover

---

The cables are connected at the back of the monitor.

**CAUTION:** Before connecting the cables to your touchmonitor and PC, be sure that the computer and touchmonitor are turned off.



To remove the cable cover, place your thumbs at the top corners of the cable cover where the indents are (above the arrows). Gently press and pull the cover toward yourself.



**NOTE:** Before connecting the cables to the touchmonitor, route all the cables that you will be using through the hole in the base as shown in the picture above. Only use one of the following: Serial or USB touch cable and D-Sub 15 video cable or DVI video cable.



The following illustrations guide you step by step in connecting your touchmonitor using a Serial or USB cable connection with D-Sub 15 or DVI video cable..



or

Connect one end of the **video cable** to the rear side of computer and the other to the LCD. Tighten by turning the two thumb screws clockwise to ensure proper grounding. You can select D-SUB15 video cable or DVI video cable, shown respectively.



Connect one end of the **speaker cable** to the speaker port in the computer and the other end to the port in the monitor.



or

Connect one end of the Serial or **USB cable** to the rear side of the computer and the other to the LCD monitor, shown respectively.



Connect the cylindrical connector from the power adaptor to the monitor. Connect the appropriate power cord to the power adaptor and to the appropriate power outlet.



## Replace the Cable Cover

---



After you have attached all the cables to the monitor; gently bring all the cables toward the center so they fit under the cable cover lip. Snap the cable cover in place over the connections.

## Optimizing the LCD Monitor

---

To ensure the LCD monitor works well with your computer, configure the monitor mode of your graphic card to make it less than or equal to 1024 x 768 resolution, and make sure the timing of the monitor mode is compatible with the LCD monitor. Refer to Appendix A for more information about resolution. Compatible video modes for your touchmonitor are listed in Chapter 8.

## Installing the Touch Driver Software

---

Driver software that allows your touchmonitor to work with your computer comes with the Elo TouchSystems monitor. Drivers are located on the enclosed TouchTools CD-ROM for the following operating systems:

- • Windows XP
- • Windows 2000
- • Windows Me
- • Windows 98
- • Windows 95
- • Windows NT 4.0
- • CE 2.x, 3.0, 4x
- • Windows XP Embedded
- • Windows 3.x
- • MS DOS
- • OS/2

Additional drivers and driver information for other operating systems (including Macintosh and Linux) are available on the Elo TouchSystems web site at [www.elotouch.com](http://www.elotouch.com).

Your Elo USB touchmonitor is “plug-and-play” compliant. Information on the video capabilities of your touchmonitor is sent to your video monitor adapter when Windows starts. If Windows detects your touchmonitor, follow the instructions on the screen to install a generic plug-and-play monitor. Refer to the appropriate section below for driver installation instructions.

## Installing the USB Touch Driver

---

### Installing the USB Touch Driver for Windows XP, Windows 2000, Windows Me and Windows 98

Insert the TouchTools CD-ROM in your computer’s CD-ROM drive.

If Windows XP, Windows 2000, Windows 98, or Windows Me starts the **Add New Hardware Wizard**, then:

1. Choose **Next**. Select “Search for the best driver for your device (Recommended)” and choose **Next**.
2. When a list of search locations is monitored, place a checkmark on “Specify a location” and use Browse to select the **\EloUSB** directory on the TouchTools CD-ROM.
3. Choose **Next**. Once the Elo TouchSystems USB touchscreen driver has been detected, choose **Next** again.
4. You will see several files being copied. Insert your Windows 98 CD if prompted. Choose **Finish**.

If Windows XP, Windows 2000, Windows 98, or Windows Me does not start the Add New Hardware Wizard:

*NOTE: For Windows XP and Windows 2000, you must have administrator access rights to install the driver.*

5. If the AutoStart feature for your CD-ROM drive is active, the system automatically detects the CD and starts the setup program.
6. Follow the directions on the screen to complete the driver setup for your version of Windows.

If the AutoStart feature is not active:

1. Click Start > Run.
2. Click the **Browse** button to locate the **EloCd.exe** program on the CD-ROM.
3. Click **Open**, then **OK** to run **EloCd.exe**.

Follow the directions on the screen to complete the driver setup for your version of Windows.

# Chapter 3: Operation

## About Touchmonitor Adjustments

---

Your touchmonitor will unlikely require adjustment. Variations in video output and application may require adjustments to your touchmonitor to optimize the quality of the display.

For best performance, your touchmonitor should be operating in native resolution, that is 1024x768 at 60-75 Hz. Use the Display control panel in Windows to choose 1024x768 resolution. Operating in other resolutions will degrade video performance. For further information, please refer to Appendix A. All adjustments you make to the controls are automatically memorized. This feature saves you from having to reset the choices every time the power is unplugged or the touchmonitor is turned off and on. If there is a power failure, your touchmonitor settings will not default to the factory specifications.

To restore factory set up, choose it from the OSD. See **Recall Defaults**.

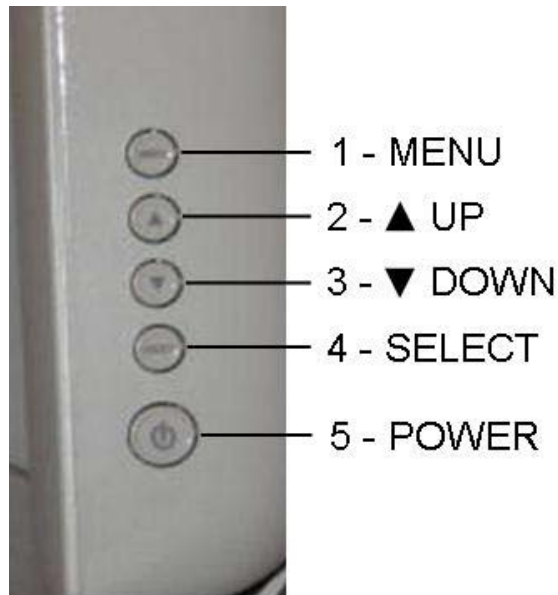

Table 1 - User controls

#	Control	Function
1	MENU	Menu monitor and menu exit.
2	▲	Adjusts the increasing value of the selected OSD control option.
3	▼	Adjusts the decreasing value of the selected OSD control option. (Hot-Button for Audio Volume)
4	SELECT	Monitors the OSD menus on the screen and used to select (“Clockwise” and “Counter-clockwise” direction) the OSD control options on the screen. (Hot-Button for Auto-Adjust)
5	POWER	Turns the monitor system power on or off.

## Controls and Adjustment

---

### OSD Menu Functions

To monitor the OSD Menu, press the **MENU** button.

- 1 Press the ▲ button or the ▼ button to select the different OSD control option.
- 2 When the function you want to change is monitored, press the **Select** button.

To adjust the Value of the function:

- 1 Press the ▲ button to increase the value of the selected OSD control option.
  - 2 Press the ▼ button to decrease the value of the selected OSD control option.
- After adjusting the values, the monitor will automatically save the changes.

**NOTE:** The OSD screen will disappear if no input activities are detected for 45 seconds.

### OSD Lock/Unlock.

You are able to lock and unlock the OSD feature. The monitor is shipped in the unlocked position.

#### To lock the OSD:

Press the **MENU** button and the ▲ button simultaneously for 2 seconds. A window will appear monitoring **OSD UNLOCK**. Continue to hold the buttons down for another 2 seconds and the window toggles to **OSD LOCK**. Repeat this procedure to unlock (toggle) the OSD feature.

### Power Lock/Unlock

You are able to lock/unlock the Power feature. The monitor is shipped in the unlocked position.

#### To lock the power:

Press the **MENU** button and the ▼ button simultaneously for 2 seconds. A window will appear monitoring **POWER UNLOCK**. Continue to hold the buttons for another 2 seconds and the window toggles to **POWER LOCK**. Repeat this procedure to unlock (toggle) the Power button.

Figure 1 - OSD Main Menu

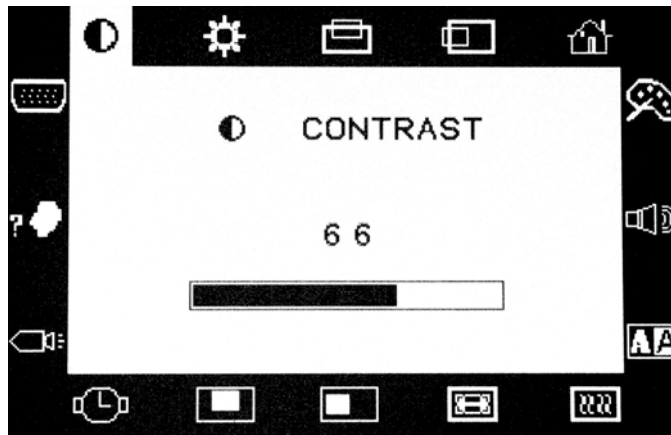

### OSD Control Options (Clockwise)

#### Contrast

- Adjusts the contrast or the values of color gain (RED, GREEN or BLUE).

#### Brightness

- Background luminance of the LCD panel is adjusted.

#### Vertical Position

- Adjusts vertical position of image.

#### Horizontal Position

- Adjusts horizontal position of image.

#### Recall Defaults

- Recalls the factory OSD default settings.

#### RGB - Color Temperature

- Select preset color temperature of 9300°K, 6500°K, 5500°K, 7500°K or select USER to customize Red, Green and Blue gain.

#### Audio

- Adjust audio volume of speakers internal to the 1528L monitor.

#### Sharpness

- Adjust image sharpness.

#### Phase

- Adjusts the phase of the dot clock. Adjust for best image.

#### Clock

- Adjusts the ratio of dividing frequency of the dot clock. Adjust to remove vertical dark bands in image.

#### OSD Left/Right

- The OSD screen is moved vertically right and left.

#### OSD Up/Down

- The OSD screen is moved vertically up and down.

#### OSD Timeout

- Adjusts the amount of time in which the OSD will disappear (45 to 255 seconds).

#### Auto Adjust

- Horizontal and vertical frequencies are monitored. Press select to automatically adjust image (under 5 seconds).

#### Language

- Selects the languages used for OSD menu monitor.

#### Input Select

- Use to select analog or digital input.

# Power LED Monitor & Power Saving

## General Power Saving Mode

When the power is on and video is present, this LED lights in **green**.

The LED indicates the different power status with altered LED colors when monitor operates in different modes (see following table).

Table 2 - Power Saving Indicator

Mode	Power Consumption	Indicator
On	30 w max.	Green
Sleep	6 w max.	Orange
Off	5 w	NO

*Note: If the monitor is not to be used for an extended period of time, it is recommended that the monitor be turned off.*

## Monitor Angle (desktop only)

For viewing clarity, you can tilt the LCD forward or back for the best viewing angle and minimum glare.

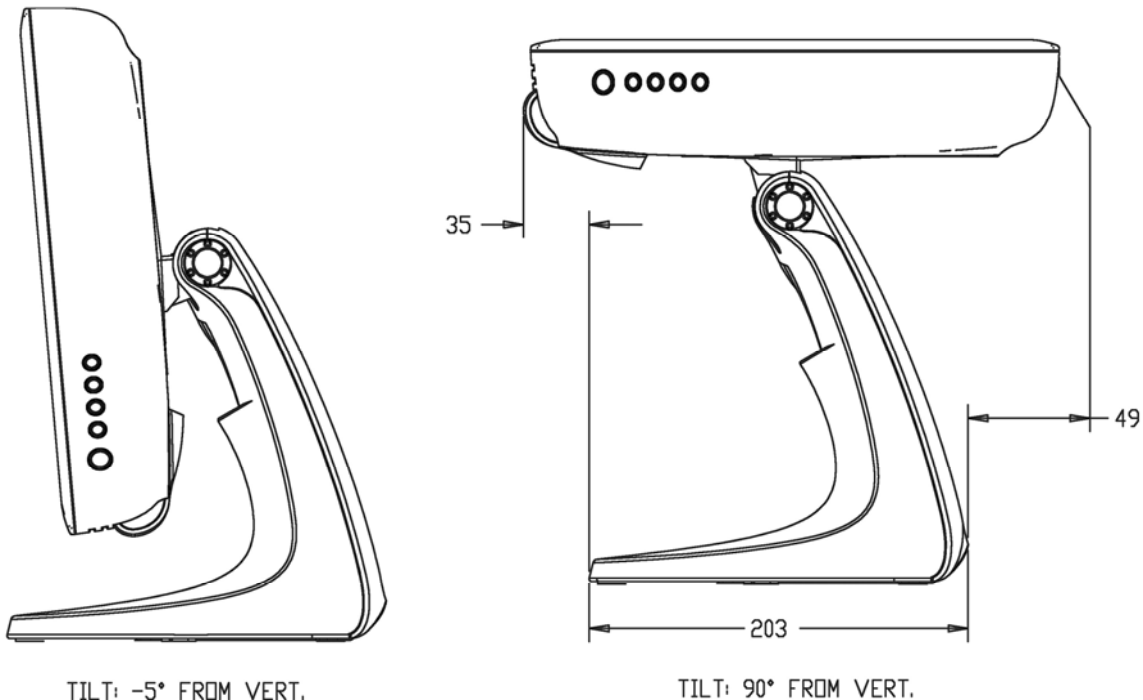

### CAUTION

- In order to protect the LCD, be sure to hold the base when adjusting the LCD.
- For models without a touchscreen take care not to touch the screen.

# Chapter 4: Troubleshooting

If you are experiencing trouble with your touchmonitor, refer to the following table. If the problem persists, please contact your local dealer or our service center. Elo Technical Support numbers are listed on page 28.

## Solutions to Common Problems

---

Problem	Suggestion(s)
The monitor does not respond	<ul style="list-style-type: none"><li>• Check that the monitor's Power Switch is on.</li><li>• Turn off the power and check the monitor's power cord and signal cable for proper connection.</li></ul>
Characters on the screen are dim	<ul style="list-style-type: none"><li>• Refer to the <i>Controls and Adjustments</i> section to adjust the brightness.</li></ul>
The screen is blank	<ul style="list-style-type: none"><li>• During operation, the monitor screen may automatically turn off as a result of the Power Saving feature. Press any key to see if the screen reappears.</li><li>• Refer to the <i>Controls and Adjustments</i> section to adjust the brightness.</li></ul>
OSD or power buttons don't work	<ul style="list-style-type: none"><li>• Check to see that they are not locked out. See page 13.</li></ul>
"Out of Range" monitor	<ul style="list-style-type: none"><li>• Check to see if the resolution or vertical frequency of your computer is higher than that of the LCD monitor.</li><li>• Reconfigure the resolution of your computer to make it less than or equal to 1024x768. 1024x768 is optimal. See Appendix A for more information on resolution.</li></ul>
Touch doesn't work	<ul style="list-style-type: none"><li>• Make sure cable is securely attached at both ends.</li></ul>

# Chapter 5: Native Resolution

The native resolution of a monitor is the resolution level at which the LCD panel is designed to perform best. For the Elo Touch Solutions LCD touchmonitor, the native resolution is 1024 x 768 for the 15.0 inch size. In almost all cases, screen images look best when viewed at their native resolution. You can lower the resolution setting of a monitor but not increase it.

<b>Input Video</b>	<b>15.0" LCD</b>
640x480 (VGA)	Transforms input format to 1024x768
800x600 (SVGA)	Transforms input format to 1024x768
1024x768(XGA)	Monitor in Native Resolution

The native resolution of an LCD is the actual number of pixels horizontally in the LCD by the number of pixels vertically in the LCD. LCD resolution is usually represented by the following symbols:

<b>VGA</b>	<b>640x480</b>
<b>SVGA</b>	<b>800x600</b>
<b>XGA</b>	<b>1024x768</b>

As an example, a SVGA resolution LCD panel has 800 pixels horizontally by 600 pixels vertically. Input video is also represented by the same terms. XGA input video has a format of 1024 pixels horizontally by 768 pixels vertically. When the input pixels contained in the video input format match the native resolution of the panel, there is a one to one correspondence of mapping of input video pixels to LCD pixels. As an example, the pixel in column 45 and row 26 of the input video is in column 45 and row 26 of the LCD. For the case when the input video is at a lower or higher resolution than the native resolution of the LCD, the direct correspondence between the video pixels and the LCD pixels is lost. The LCD controller can compute the correspondence between video pixels and LCD pixels using algorithms contained on its controller. The accuracy of the algorithms determines the fidelity of conversion of video pixels to LCD pixels. Poor fidelity conversion can result in artifacts in the LCD displayed image such as varying width characters.



# Chapter 6: Touchmonitor Safety

This manual contains information that is important for the proper setup and maintenance of your touchmonitor. Before setting up and powering on your new touchmonitor, read through this manual, especially Chapter 2 (Installation), and Chapter 3 (Operation).

1. To reduce the risk of electric shock, follow all safety notices and never open the touchmonitor case.
2. Turn off the product before cleaning. (See page 19 for Cleaning Instructions.)
3. Your touchmonitor is equipped with a 3-wire, grounding power cord. The power cord plug will only fit into a grounded outlet. Do not attempt to fit the plug into an outlet that has not been configured for this purpose. Do not use a damaged power cord. Use only the power cord that comes with your Elo TouchSystems touchmonitor. Use of an unauthorized power cord may invalidate your warranty.
4. The slots located on the sides and top of the touchmonitor case are for ventilation. Do not block or insert anything inside the ventilation slots.
5. It is important that your touchmonitor remains dry. Do not pour liquid into or onto your touchmonitor. If your touchmonitor becomes wet do not attempt to repair it yourself.

# Care and Handling of Your Touchmonitor

The following tips will help keep your Elo TouchSystems touchmonitor functioning at the optimal level.

- To avoid risk of electric shock, do not disassemble the power adaptor or monitor cabinet. The monitor is not user serviceable. Remember to unplug the monitor from the power outlet before cleaning.
- Do not use alcohol (methyl, ethyl or isopropyl) or any strong dissolvent on the monitor. Do not use thinner or benzene, abrasive cleaners or compressed air on the monitor.
- To clean the monitor cabinet, use a soft cloth lightly dampened with a mild detergent.
- Avoid getting liquids inside your touchmonitor. If liquid does get inside, have a qualified service technician check it before you power it on again.
- Do not wipe the screen with a cloth or sponge that could scratch the surface.

To clean the touchscreen, use window or glass cleaner. Put the cleaner on a soft cloth and wipe the touchscreen. *Never* apply the cleaner directly on the touchscreen.

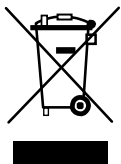

## Waste Electrical and Electronic Equipment(WEEE) Directive

In the European Union, this label indicates that this product should not be disposed of with household waste. It should be deposited at an appropriate facility to enable recovery and recycling.

# Chapter 7: Technical Specifications

## Display Modes

Your Elo Touch Solutions touchmonitor is compatible with the following standard video modes:

**Table 3 – Monitor Modes**

Item	Resolution	Type	H. Scan (KHz)	V. Scan (Hz)	Polarity
1	640X350	VGA	31.469	70.087	+ /
2	720X400	VGA	31.469	70.087	- / +
3	640X480	VGA	31.469	59.940	- /
4	640X480	VESA 72	37.861	72.809	- /
5	640X480	VESA 75	37.500	75.000	- /
6	800X600	SVGA	35.156	56.250	+ / +
7	800X600	SVGA	37.879	60.317	+ / +
8	800X600	VESA 72	48.077	72.188	+ / +
9	800X600	VESA 75	46.875	75.000	+ / +
10	1024X768	XGA	48.363	60.004	- / -
11	1024X768	XGA	56.476	70.069	- / -
12	1024X768	VESA 75	60.023	75.029	+ / +

## 1528L - Touch Display Specifications

Table 4 – Touch Display Specifications

Parameter	Value
<b>LCD Display</b>	15.0" TFT Active Matrix Panel
<b>Pixel Pitch</b>	0.297(H) x 0.297(V) mm
<b>Monitor Mode</b>	VGA 640 x 350 (70 Hz) VGA 720 x 400 (70 Hz) VGA 640 x 480 (60 / 72 / 75 Hz) SVGA 800 x 600 (56 / 60 / 72 / 75 Hz) XGA 1024 x 768 (60 / 70 / 75 Hz)
<b>Native</b>	XGA 1024 x 768
<b>Contrast Ratio</b>	400 : 1 (typical)
<b>Brightness</b>	LCD 350 cd/m <sup>2</sup> (Typical) AccuTouch 287 cd/m <sup>2</sup> (Typical) IntelliTouch 322 cd/m <sup>2</sup> (Typical) CarrollTouch 322 cd/m <sup>2</sup> (Typical) Surface Capacitive 322 cd/m <sup>2</sup> (Typical)
<b>Response Time</b>	Tr = 12 msec, Tf = 16 msec typical
<b>Monitor Color</b>	16.2 million color, 6 bit with dithering
<b>Viewing Angle</b>	(L/R)= -60°/+60° (typical), (U/D) -60°/+40° (typical)
<b>Input Signal</b>	VGA Analog Video R.G.B. Analog 0.7V peak to peak Sync TTL Positive or Negative, Composite Sync, Sync on green DVI Video Digital TMDS Input
<b>Signal Connector</b>	15 Pin D-Sub or DVI-D
<b>Front Control</b>	Power ON / OFF, Menu, Select
<b>OSD</b>	Contrast, Brightness, H/V-Position, Recall default, Color Temperature, Volume, Saturation, Hue, Flash Tone, Phase, Clock OSD H/V position, OSD Time, Auto Adjust, OSD Language, Input Select
<b>Plug &amp; Play</b>	DDC1 / 2B
<b>Touchscreen</b>	AccuTouch, IntelliTouch, CarrollTouch, and SecureTouch
<b>Technology</b>	
<b>Power</b>	
<b>External Power Adaptor*</b>	AC 100-240V, 50-60 Hz
<b>Display</b>	DC 12V, 2.5 A
<b>Environmental</b>	
<b>Temp. Operating</b>	0°C to 40°C
<b>Storage</b>	-20°C to +60°C
<b>Humidity (non-condensing)</b>	
<b>Operating</b>	20% to 80%
<b>Storage</b>	5% to 90%
<b>Altitude Operating</b>	0 to + 12,000 feet [3,658m]. Equiv. to 14.7 to 10.1 psia.
<b>Storage</b>	0 to + 40,000 feet [12,192m]. Equiv. to 14.7 to 4.4 psia.
<b>Dimensions (H x W x D)</b>	354 x 301 x 285 mm
<b>Weight (Net)</b>	20.1lbs., display weight 16.2 lbs. (with standard base attached)
<b>Certifications</b>	UL, cUL, DEMKO, CE, FCC-B, VCCI, MPRII, C-TICK

**\* FOR CONTINUED SAFETY - Use only with Hitron Model HEMG49-S12040-7 power adapter.**

# Power Adapter Cord Selection

---

## North America

Power Adapter Cord – Detachable, UL Listed, Type SJT 3 conductor, 18 AWG, configured load fittings terminating in molded on parallel blade. Grounding type hospital grade attachment plug, rated at a minimum of 3 amperes.

Grounding reliability can only be achieved when the touchmonitor EQUIPMENT is connected to an equivalent receptacle marked “Hospital Only” or “Hospital Grade”.

**Table 5 - Equivalent Types**

Basic Cord Type	Equivalent Types
SP-2	SPE-2, SPT-2
SP-3	SPE-3, SPT-3
SV	SVE, SVO, SVOO, SVT, SVTO, SVTOO
SJ	SJE, SJO, SJOO, SJT, SJTO, SJTOO
S	SE, SO, SOO, ST, STO, STOO

### Cord selection for other than North America

For 100 V ac or 220/230/240 V ac operation, the touchmonitor is provided with IEC 320 flexible power cords properly configured for the intended country other than North America. The NOMINAL cross-sectional area (mm<sup>2</sup> CU) must be 0,75. For assistance in selecting the proper power cord contact the Elo TouchSystems distributor in your area or contact Elo TouchSystems directly (see Appendix D, page 29).

<b>Cert. Country</b>	<b>Cert. Agency</b>	<b>Mark</b>	<b>Country</b>	<b>Agency</b>	<b>Mark</b>
Argentina	IRAM		Ireland	NSAI	
Australia	SAA		Italy	IMQ	
Austria	OVE		Japan	MITI	
Belgium	CEBEC		Netherlands	KEMA	
Canada	CSA		Norway	NEMKO	
China	CCEE		Spain	AEE	
Denmark	DEMKO		Sweden	SEMKO	
Finland	FEI		Switzerland	SEV	
France	UTE		United Kingdom	ASTA	
Germany	VDE		United Kingdom	BSI	

**Table 6 - HAR FLEXIBLE CORD**

Approval Organization	Printed or Embossed Harmonization Marking (May be Located On Jacket or Insulation of Internal Wiring)		Alternative Marking Utilizing Black-Red Yellow Thread (Length of color Section, mm)		
Comite Electrotechnique Belge (CEBEC)	CEBEC	<HAR>	10	30	10
Verband Deutscher Elektrotechniker (VDE) e.V. Prufstelle	<VDE>	<HAR>	30	10	10
Union technique de l'Electricite (UTE)	USE	<HAR>	30	10	30
Instituto Italiano del Marchio di Qualita (IMQ)	IEMMEQU	<HAR>	10	30	50
British Approvals Service for Electric Cables (BASEC)	BASEC	<HAR>	10	10	30
N> V. KEMA	KEMA-KEUR	<HAR>	10	30	30
SEMKO AB Svenska Elektriska Materielkontrollanstalter	SEMKO	<HAR>	10	10	50
Österreichischer Verband fur Elektrotechnik (ÖVE)	<ÖVE>	<HAR>	30	10	50
Danmarks Elektriske Materialkontroll (DEMKO)	<DEMKO>	<HAR>	30	10	30
National Standards Authority of Ireland (NSAI)	<NSAI>	<HAR>	30	30	50
Norges Elektriske Materieilkontroll (NEMKO)	NEMKO	<HAR>	10	10	70
Asociacion Electrotecnica Y Electronica Espanola (AEE)	<UNED>	<HAR>	30	10	70
Hellenic Organization for Standardization (ELOT)	ELOT	<HAR>	30	30	70
Instituto Portages da Qualidade (IPQ)	np	<HAR>	10	10	90
Schweizerischer Elektro Technischer Verein (SEV)	SEV	<HAR>	10	30	90
Elektriska Inspektoratet	SETI	<HAR>	10	30	90

# Table 7 IntelliTouch (surface acoustic wave) Technology Touchscreen Specifications

---

## Mechanical

---

<b>Positional Accuracy</b>	Standard deviation of error is less than 0.080 in. (2.03 mm). Equates to less than $\pm 1\%$ .
<b>Touchpoint Density</b>	More than 100,000 touch points/in <sup>2</sup> (15,500 touch points/cm <sup>2</sup> ).
<b>Touch Activation Force</b>	Typically less than 3 ounces (85 grams).
<b>Surface Durability</b>	Surface durability is that of glass, Mohs' hardness rating of 7.
<b>Expected Life Performance</b>	No known wear-out mechanism, as there are no layers, coatings, or moving parts. IntelliTouch technology has been operationally tested to more than 50 million touches in one location without failure, using a stylus similar to a finger.
<b>Sealing</b>	Unit is sealed to protect against splashed liquids, dirt, and dust.

## Optical

---

<b>Light Transmission (per ASTM D1003)</b>	90%
<b>Visual Resolution</b>	All measurements made using USAF 1951 Resolution Chart, under 30X magnification, with test unit located approximately 1.5 in (38 mm) from surface of resolution chart. Clear surface: Excellent, with no noticeable degradation. Antiglare surface: 6:1 minimum.
<b>Gloss (per ASTM D2457 using a 60-degree gloss meter)</b>	Antiglare surface: Curved: $60 \pm 20$ gloss units or $75 \pm 15$ gloss units.

## Environmental

---

<b>Chemical Resistance</b>	<b>The active area of the touchscreen is resistant to all chemicals that do not affect glass, such as:</b>  Acetone, Toluene, Methyl ethyl ketone, Isopropyl alcohol, Methyl alcohol, Ethyl acetate, Ammonia-based glass cleaners, Gasoline, Kerosene, Vinegar
<b>Electrostatic Protection (per EN 61 000-4-2, 1995)</b>	<b>Meets Level 4 (15 kV air/8 kV contact discharges).</b>



# Table 8 AccuTouch (resistive) Technology Touchscreen Specifications

---

## Mechanical

---

<b>Construction</b>	<p>Top: Polyester with outside hard-surface coating with clear or antiglare finish.</p> <p>Inside: Transparent conductive coating.</p> <p>Bottom: Glass substrate with uniform resistive coating. Top and bottom layers separated by Elo-patented separator dots.</p>
<b>Positional Accuracy</b>	Standard deviation of error is less than 0.080 in. (2.03 mm). This equates to less than $\pm 1\%$ .
<b>Touchpoint Density</b>	More than 100,000 touchpoints/in <sup>2</sup> (15,500 touchpoints/cm <sup>2</sup> ).
<b>Touch Activation Force</b>	Typically less than 4 ounces (113 grams).
<b>Surface Durability</b>	Meets Taber Abrasion Test (ASTM D1044), CS-10F wheel, 500 g. Meets pencil hardness 3H.
<b>Expected Life Performance</b>	AccuTouch technology has been operationally tested to greater than 35 million touches in one location without failure, using a stylus similar to a finger.

## Optical

---

<b>Light Transmission (per ASTM D1003)</b>	Typically 75% at 550-nm wavelength (visible light spectrum).
<b>Visual Resolution</b>	<p>All measurements made using USAF 1951 Resolution Chart, under 30 X magnification, with test unit located approximately 1.5 in. (38 mm) from surface of resolution chart.</p> <p>Antiglare surface: 6:1 minimum.</p>
<b>Haze (per ASTM D1003)</b>	Antiglare surface: Less than 15%.
<b>Gloss (per ASTM D2457)</b>	Antiglare surface: 90 $\pm$ 20 gloss units tested on a hard-coated front surface.

# Table 9 CarolITouch (infrared) Technology Touchscreen Specifications

---

## Mechanical

---

**Input Method** Input Method Finger or gloved hand activation

## Electrical

---

**Positional Accuracy** Typical centroid accuracy: 2 mm with 1 mm STD error

**Resolution** Touch point density is based on controller resolution of 4096 x 4096

**Touch Activation Force** No minimum touch activation force is required

**Controller** Board: Serial (RS232) or USB 1.1

## Optical

---

**Light Transmission** Glass overlay: 90% per ASTM D1003-92

## Environmental

---

**Chemical Resistance** Glass overlays: The touch active area of the touchscreen is resistant to chemicals that do not affect glass, such as: acetone, toluene, methyl ethyl ketone, isopropyl alcohol, methyl alcohol, ethyl acetate, ammonia-based glass cleaners, gasoline, kerosene, vinegar. Polycarbonate bezel: around perimeter of monitor has some sensitivity to hydrocarbons.

## Durability

**Surface Durability** Glass filter option: Surface durability is that of glass, Mohs' hardness rating of 7.

# Chapter 8: Contact Elo Touch Solutions

## Contact Elo TouchSystems

---

Elo Touch Solutions, Inc.  
301 Constitution Drive  
Menlo Park, CA 94025  
1-800-557-1458 (telephone)  
1-650-361-4722 (facsimile)  
www.elotouch.com

### Replacement Parts

---

<u>Item</u>	<u>Part Number</u>
Medical grade power adapter	E448370
Hospital Grade power cord, 10'	82-1184-00-2
User Manual	E894354
Video Cable (VGA), beige	5313018038F0
Video Cable (VGA), black	5313018037F0
Video Cable (DVI), Beige	5313118055F0
Video Cable (DVI), black	5313118054F0
Serial Cable, beige	5313118046F0
Serial Cable, black	5313118045F0
USB Cable, beige	5313118048F0
USB Cable, black,	5313118047F0
Audio Cable, beige	5313118053F0
Audio Cable, black	5313118052F0

# Chapter 9: Regulatory Information

## I. Electrical Safety Information:

A) Compliance is required with respect to the voltage, frequency, and current requirements indicated on the manufacturer's label. Connection to a different power source than those specified herein will likely result in improper operation, damage to the equipment or pose a fire hazard if the limitations are not followed.

B) There are no operator serviceable parts inside this equipment. There are hazardous voltages generated by this equipment which constitute a safety hazard. Service should be provided only by a qualified service technician.

C) This equipment is provided with a detachable power cord which has an integral safety ground wire intended for connection to a grounded safety outlet.

1) Do not substitute the cord with other than the provided approved type. Under no circumstances use an adapter plug to connect to a 2-wire outlet as this will defeat the continuity of the grounding wire.

2) The equipment requires the use of the ground wire as a part of the safety certification. Modification or misuse can provide a shock hazard that can result in serious injury or death.

3) Contact a qualified electrician or the manufacturer if there are questions about the installation prior to connecting the equipment to mains power.

## II. Emissions and Immunity Information

A) Notice to Users in the United States: This equipment has been tested and found to comply with the limits for a Class B digital device, pursuant to Part 15 of FCC Rules. These limits are designed to provide reasonable protection against harmful interference in a residential installation. This equipment generates, uses, and can radiate radio frequency energy, and if not installed and used in accordance with the instructions, may cause harmful interference to radio communications.

B) Notice to Users in Canada: This equipment complies with the Class B limits for radio noise emissions from digital apparatus as established by the Radio Interference Regulations of Industrie Canada.

C) Notice to Users in the European Union: Use only the provided power cords and interconnecting cabling provided with the equipment. Substitution of provided cords and cabling may compromise electrical safety or CE Mark Certification for emissions or immunity as required by the following standards:

This Information Technology Equipment is required to have a CE Mark on the manufacturer's label which means that the equipment has been tested to the following Directives and Standards:

This equipment has been tested to the requirements for the CE Mark as required by Low Voltage Directive (LVD) 2006/95/EC indicated in European Standard EN60950-1 and the EMC Directive 2004/108/EC indicated in European Standard EN55022, EN61000-3-2, EN61000-3-3 and EN55024.

D) General Information to all Users: This equipment generates, uses and can radiate radio frequency energy. If not installed and used according to this manual the equipment may cause interference with radio and television communications. There is, however, no guarantee that interference will not occur in any particular installation due to site-specific factors.

1) In order to meet emission and immunity requirements, the user must observe the following:

- a) Use only the provided I/O cables to connect this digital device with any computer.
- b) To ensure compliance, use only the provided manufacturer's approved power cord.
- c) The user is cautioned that changes or modifications to the equipment not expressly approved by the party responsible for compliance could void the user's authority to operate the equipment.

2) If this equipment appears to cause interference with radio or television reception, or any other device:

- a) Verify as an emission source by turning the equipment off and on.
- b) If you determine that this equipment is causing the interference, try to correct the interference by using one or more of the following measures:
  - i) Move the digital device away from the affected receiver.
  - ii) Reposition (turn) the digital device with respect to the affected receiver.
  - iii) Reorient the affected receiver's antenna.
  - iv) Plug the digital device into a different AC outlet so the digital device and the receiver are on different branch circuits.
  - v) Disconnect and remove any I/O cables that the digital device does not use. (Unterminated I/O cables are a potential source of high RF emission levels.)
  - vi) Plug the digital device into only a grounded outlet receptacle. Do not use AC adapter plugs. (Removing or cutting the power cord ground may increase RF emission levels and may also present a lethal shock hazard to the user.)

If you need additional help, consult your dealer, manufacturer, or an experienced radio or television technician.



# Chapter 10: Warranty

Except as otherwise stated herein, or in an order acknowledgment delivered to Buyer, Seller warrants to Buyer that the Product shall be free of defects in materials and workmanship. The warranty for the TouchMonitors and their components is 1 (one) year.

Seller makes no warranty regarding the model life of components. Seller's suppliers may at any time and from time to time make changes in the components delivered as Products or components.

Buyer shall notify Seller in writing promptly (and in no case later than thirty days after discovery) of the failure of any Product to conform to the warranty set forth above; shall describe in commercially reasonable detail in such notice the symptoms associated with such failure; and shall provide to Seller the opportunity to inspect such Products as installed, if possible. The notice must be received by Seller during the Warranty Period for such product, unless otherwise directed in writing by the Seller. Within thirty days after submitting such notice, Buyer shall package the allegedly defective Product in its original shipping carton(s) or a functional equivalent and shall ship to Seller at Buyer's expense and risk.

Within a reasonable time after receipt of the allegedly defective Product and verification by Seller that the Product fails to meet the warranty set forth above, Seller shall correct such failure by, at Seller's options, either (i) modifying or repairing the Product or (ii) replacing the Product. Such modification, repair, or replacement and the return shipment of the Product with minimum insurance to Buyer shall be at Seller's expense. Buyer shall bear the risk of loss or damage in transit, and may insure the Product. Buyer shall reimburse Seller for transportation cost incurred for Product returned but not found by Seller to be defective. Modification or repair, of Products may, at Seller's option, take place either at Seller's facilities or at Buyer's premises. If Seller is unable to modify, repair, or replace a Product to conform to the warranty set forth above, then Seller shall, at Seller's option, either refund to Buyer or credit to Buyer's account the purchase price of the Product less depreciation calculated on a straight-line basis over Seller's stated Warranty Period.

These remedies shall be the buyer's exclusive remedies for breach of warranty. Except for the express warranty set forth above, seller grants no other warranties, express or implied by statute or otherwise, regarding the products, their fitness for any purpose, their quality, their merchantability, their non-infringement, or otherwise. No employee of Seller or any other party is authorized to make any warranty for the goods other than the warranty set forth herein. Seller's liability under the warranty shall be limited to a refund of the purchase price of the product. In no event shall Seller be liable for the cost of procurement or installation of substitute goods by Buyer or for any special, consequential, indirect, or incidental damages.

Buyer assumes the risk and agrees to indemnify Seller against and hold Seller harmless from all liability relating to (i) assessing the suitability for Buyer's intended use of the Products and of any system design or drawing and (ii) determining the compliance of Buyer's use of the Products with applicable laws, regulations, codes, and standards. Buyer retains and accepts full responsibility for all warranty and other claims relating to or arising from Buyer's products, which include or incorporate Products or components manufactured or supplied by Seller. Buyer is solely responsible for any and all representations and warranties regarding the Products made or authorized by Buyer. Buyer will indemnify Seller and hold Seller harmless from any liability, claims, loss, cost, or expenses (including reasonable attorney's fees) attributable to Buyer's products or representations or warranties concerning same.

# Check out Elo's Website!

## [www.elotouch.com](http://www.elotouch.com)

---

Get the latest...

- Product information
- Specifications
- News on upcoming events
- Press release
- Software drivers
- Touchmonitor Newsletter

## Getting in Touch with Elo

---

To find out more about Elo's extensive range of touch solutions, visit our Website at [www.elotouch.com](http://www.elotouch.com) or simply call the office nearest you:

**North America**  
Elo Touch Solutions  
301 Constitution Drive  
Menlo Park, CA 94025

Tel 800-ELO-TOUCH  
Tel 1-650-361-4800  
Fax 1-650-361-4722  
[customerservice@elotouch.com](mailto:customerservice@elotouch.com)

**Europe**  
Tel +32(0)(16)35-2100  
Fax +32(0)(16)35-2101  
[elosales@elotouch.com](mailto:elosales@elotouch.com)

**Asia-Pacific**  
Tel +81(45)478-2161  
Fax +81(45)478-2180  
[www.tps.co.jp](http://www.tps.co.jp)

**Latin America**  
Tel 786-923-0251  
Fax 305-931-0124  
[www.elotouch.com.ar](http://www.elotouch.com.ar)

Copyright 2012 Elo Touch Solutions, Inc. All rights reserved.