

Elo Entuitive Touchmonitor User Guide

12.1" LCD Desktop Touchmonitor

1224L Series

entuitive
Touchmonitors

Revision B

P/N 008546

Elo TouchSystems, Inc.

1-800-ELOTOUCH
www.elotouch.com

tyco
Electronics

ēlo
TOUCHSYSTEMS

Copyright © 2005 Elo TouchSystems Inc. All Rights Reserved.

No part of this publication may be reproduced, transmitted, transcribed, stored in a retrieval system, or translated into any language or computer language, in any form or by any means, including, but not limited to, electronic, magnetic, optical, chemical, manual, or otherwise without prior written permission of Elo TouchSystems.

Disclaimer

The information in this document is subject to change without notice. Elo TouchSystems makes no representations or warranties with respect to the contents hereof, and specifically disclaims any implied warranties of merchantability or fitness for a particular purpose. Elo TouchSystems reserves the right to revise this publication and to make changes from time to time in the content hereof without obligation of Elo TouchSystems to notify any person of such revisions or changes.

Trademark Acknowledgments

IntelliTouch, SecureTouch, AccuTouch, Entuitive, and MonitorMouse are trademarks of Elo TouchSystems, Inc.

Other product names mentioned herein may be trademarks or registered trademarks of their respective companies. Elo TouchSystems claims no interest in trademarks other than its own.

◆ **Table of Contents** ◆

Chapter 1		Appendix A	
Product Description	1	Care and Handling of Your Touchmonitor	22
Precautions	1	Appendix B	
About the Product	2	Appendix C	
Chapter 2		Display Modes	23
Unpacking Your Touchmonitor.	3	Touchmonitor Specifications	24
Product Overview	4	AccuTouch Touchscreen Specifications	25
Main Unit	4	12.1" LCD Touchmonitor (ET12-XXWC-1)	
Rear View	4	Dimensions	26
Touch Interface Connection	5	Index 35	
Installing the Driver Software	6		
Installing the Serial Touch Driver.	7		
Installing the Serial Touch Driver for Windows			
2000, Me, 95/98 and NT 4.0	7		
Installing the Serial Touch Driver for MS-DOS			
and Windows 3.1	8		
Chapter 3			
About Touchmonitor Adjustments	9		
Controls and Adjustment	12		
OSD Menu Functions	12		
OSD Control Options.	13		
Brightness.	13		
Contrast/Red, Green, Blue	13		
Saturation (for models with video-in function			
only).	13		
Hue (for models with video-in function only)			
13			
Auto Setup	13		
Horizontal Position	14		
Vertical Position	14		
Frequency.	14		
Phase	14		
Track	14		
Text/Graphics	14		
Expansion.	15		
ROM/RAM Version	15		
Recall Color.	15		
Power LED Display & Power Saving	15		
General Power Saving Mode	15		
Display Angle	16		
Chapter 4			
Solutions to Common Problems.	17		

INTRODUCTION

Product Description

Congratulations on your purchase of an Elo TouchSystems Entuitive touchmonitor. Your new touchmonitor combines the reliable performance of Elo's touch technology with the latest advances in LCD display design. This combination of features creates a natural flow of information between a user and your touchmonitor.

This LCD monitor incorporates 12.1" color active matrix thin-film-transistor (TFT) liquid crystal display to provide superior display performance. A maximum resolution of SVGA 800x600 is ideal for displaying graphics and images. Other outstanding designs that enhance this LCD monitor's performance are Plug & Play compatibility, and OSD (On Screen Display) controls.

NOTE Some monitors do not have the touchscreen capability.

Precautions

Follow all warnings, precautions and maintenance as recommended in this user's manual to maximize the life of your unit. See Appendix B for more information on touchmonitor safety.

About the Product

Your LCD Desktop Touchmonitor is a 12.1" XGA TFT color display with the following features:

- High contrast color TFT LCD display support resolution up to SVGA 800x600. Compatible with IBM VGA and VESA.
- Power management system conforms to VESA DPMS standard.
- Universal power adapter.
- Supports DDC1/2B for Plug & Play compatibility.
- Advanced OSD control for picture quality adjustment.
- Detachable stand for wall-mounting application.
- Optional video-in function.
- Optional touch screen function.

For full Product Specifications refer to Appendix C.

INSTALLATION AND SETUP

This chapter discusses how to install your LCD touchmonitor and how to install Elo TouchSystems driver software.

Unpacking Your Touchmonitor

Check that the following 8 items are present and in good condition:

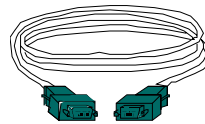
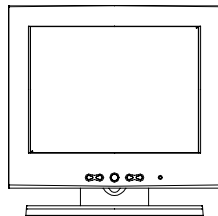

Serial cable

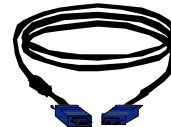

VGA cable

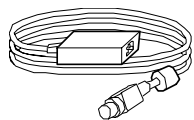

Brick power supply

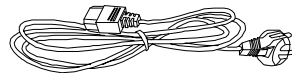

European power cable

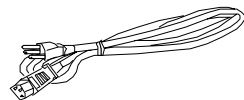

Power cable US/Canada

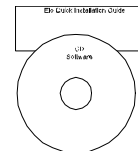

CD and Quick Install Guide

Product Overview

Main Unit

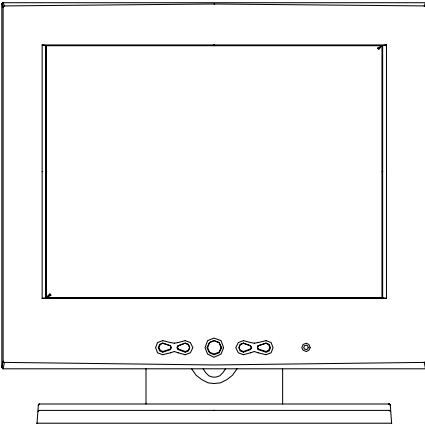

Rear View

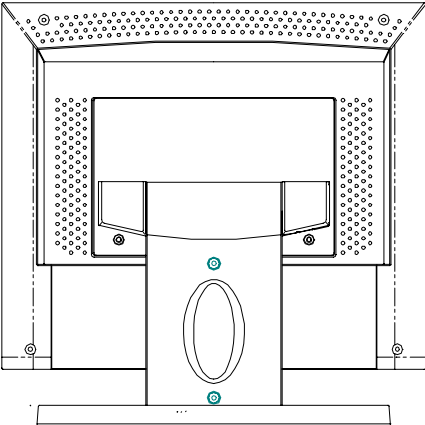

Touch Interface Connection

NOTE: Before connecting the cables to your touchmonitor and PC, be sure that the computer and touchmonitor are turned off.

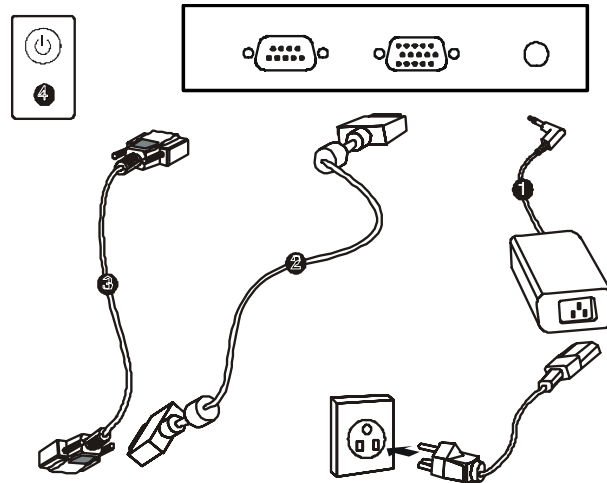

- 1** Connect one end of the **power adapter** to the monitor and the other end to the connector of the power cord.
- 2** Connect one end of the **video cable** to the rear side of computer and the other to the LCD monitor. Tighten by turning the two thumb screws clockwise to ensure proper grounding.
- 3** Connect one end of the **touchscreen (RS232) cable** to the rear side of computer and the other to the LCD monitor. Tighten by turning the two thumb screws clockwise to ensure proper grounding. (optional module)
- 4** Press the **power button** on front panel to turn the monitor power on.

Installing the Driver Software

Elo TouchSystems provides driver software that allows your touchmonitor to work with your computer. Drivers are located on the enclosed CD-ROM for the following operating systems:

- Windows 2000
- Windows Me
- Windows 98
- Windows 95
- Windows NT 4.0

Additional drivers and driver information for other operating systems (including MS DOS, Windows 3.x, OS/2, Macintosh and Linux) are available on the Elo TouchSystems web site at www.elotouch.com.

Your Elo touchmonitor is plug-and-play compliant. Information on the video capabilities of your touchmonitor is sent to your video display adapter when Windows starts. If Windows detects your touchmonitor, follow the instructions on the screen to install a generic plug-and-play monitor.

Refer to the appropriate following section for driver installation instructions.

Installing the Serial Touch Driver

Installing the Serial Touch Driver for Windows 2000, Me, 95/98 and NT 4.0

NOTE: For Windows 2000 and NT 4.0 you must have administrator access rights to install the driver.

- 1** Insert the Elo CD-ROM in your computer's CD-ROM drive.
- 2** If the AutoStart feature for your CD-ROM drive is active, the system automatically detects the CD and starts the setup program.
- 3** Follow the directions on the screen to complete the driver setup for your version of Windows.
- 4** If the AutoStart feature is not active:
- 5** Click **Start > Run**.
- 6** Click the **Browse** button to locate the EloCd.exe program on the CD-ROM.
- 7** Click **Open**, then **OK** to run EloCd.exe.
- 8** Follow the directions on the screen to complete the driver setup for your version of Windows.

Installing the Serial Touch Driver for MS-DOS and Windows 3.1

You must have a DOS mouse driver (MOUSE.COM) installed for your mouse if you wish to continue using your mouse along with your touchmonitor in DOS.

To install Windows 3.x and MS-DOS from Windows 95/98, follow the directions below:

- 1 Insert the Elo CD-ROM in your computer's CD-ROM drive.
- 2 From DOS, type `d:\EloDos_W31` to change to the correct directory on the CD-ROM (your CD-ROM drive may be mapped to a different drive letter).
- 3 Type `install` and press **Enter** to start the installation.
- 4 Align the touchscreen.

You must have already completed Steps 1 and 2 before proceeding. Refer to Chapter 2 of the Elo DOS and Windows Driver Guide as necessary for additional installation information.

To run the INSTALL program:

- 1 Type `INSTALL` at the DOS prompt in the directory containing the driver install files.
- 2 `INSTALL` asks you to select the software to install. Then choose `d:\EloDos_W31` from the displayed list.
- 3 `INSTALL` also asks you for the paths to use during installation, or you may use its defaults. `INSTALL` creates directories as necessary, and warns you if they exist.

If you are updating your software, you may wish to specify the paths containing the earlier versions, and overwrite the obsolete files. All executable programs are upward compatible. For a list of differences from each previous version of the drivers, be sure to select "Differences from Previous Versions" during the installation process.

`INSTALL` updates your `AUTOEXEC.BAT` file with the drivers you select. `INSTALL` makes a copy of your original `AUTOEXEC.BAT` file, called `AUTOEXEC.OLD`. If you already have Elo driver commands in your `AUTOEXEC.BAT` file, they will be commented out.

When `INSTALL` is finished, it leaves a file called `GO.BAT` in the subdirectory you specified. `GO` loads the touchscreen driver, runs the calibration program `ELOCALIB`, and gives you some final instructions.

If you are using Windows 3.1, you will also calibrate the touchscreen within Windows 3.1 with the Touchscreen Control Panel.

About Touchmonitor Adjustments

Your touchmonitor will unlikely require adjustment. Variations in video output and application may require adjustments to your touchmonitor to optimize the quality of the display.

For best performance, your touchmonitor should be operating in native resolution, that is 800x600 at 60-75 Hz. Use the Display control panel in Windows to choose 800x600 resolution.

Operating in other resolutions will degrade video performance. For further information, please refer to Appendix A.

All adjustments you make to the controls are automatically memorized. This feature saves you from having to reset your choices every time you unplug or power your touchmonitor off and on. If there is a power failure your touchmonitor settings will not default to the factory specifications.

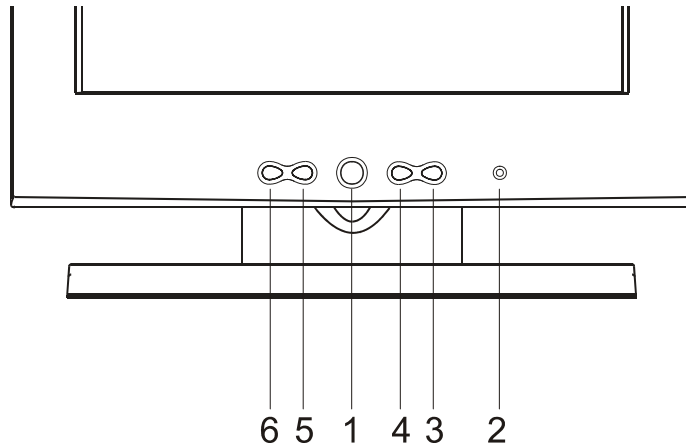

	Control	Function
1	Power Switch	Turns the display system power on or off .
2	Power LED	Indicates a different status when this unit operates in different modes.
3	Menu/Select ▲	Displays the OSD menus on the screen and used to select (“Up” direction) the OSD control options on the screen.
4	Menu/Select ▼	Displays the OSD menus on the screen and used to select (“Down” direction) the OSD control options on the screen.
5	+	Adjusts the increasing value of the selected OSD control option.
6	-	(1) Adjusts the decreasing value of the selected OSD control option. (2) Selects input source when the OSD “main menu” function is off (for model with video-in function only).

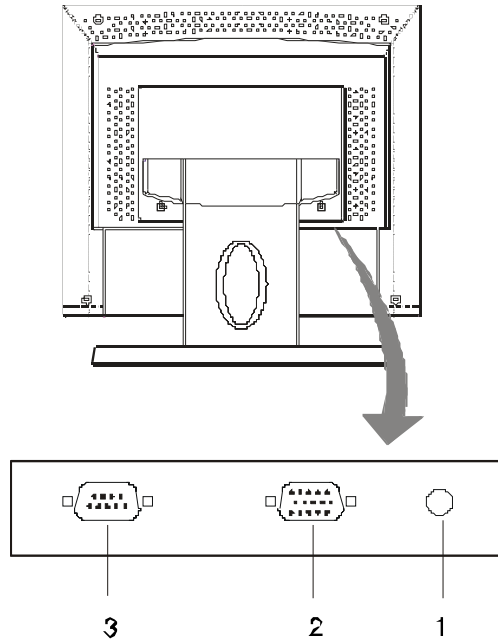

- 1 Power Connector** Connect the power adapter.
- 2 Video Connector** This can be connected with the D-sub 15 pin signal connector.
- 3 Touchscreen connector** This is for connecting the touch panel RS232 connector. (optional)

Controls and Adjustment

OSD Menu Functions

To Display and Select the OSD Functions:

- 1 Press ▲ once to display the OSD function main menu.
- 2 Press ▼ a second time to select the different OSD control option.



To Adjust the Value of the Control Option:

- 1 Pressing + / - button changes the value of the selected OSD control option.

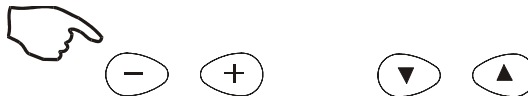

After adjusting the values, the monitor will automatically save the changes.

To select the input source (for models with video-in function.)

Press - to select input source when the OSD “main menu” function is off.

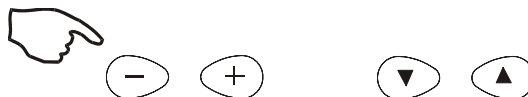

NOTE: The OSD screen will disappear if no input activities are detected for 10 seconds.

OSD Control Options

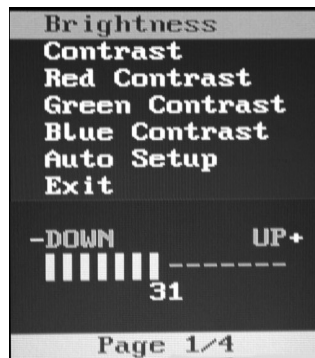

OSD Menu Page 1/4

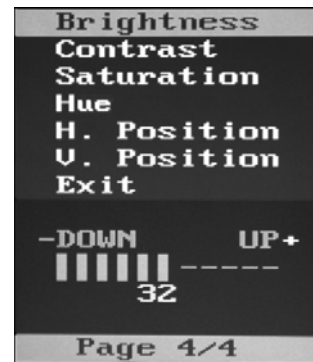

OSD Menu Page 4/4
(for models with video-in function)

Brightness

- Adjust the brightness using +and –buttons.

Contrast/Red, Green, Blue

- Adjust the contrast using +and –buttons, or adjust the values of color gain (RED, GREEN or BLUE) using +and –buttons.

Saturation (for models with video-in function only)

- Adjust the video image color saturation using + and – buttons.

Hue (for models with video-in function only)

- Adjust the video image hue using + and – buttons.

Auto Setup

- Press +buttons to make LCD monitor adjust the related parameters automatically for optimal display status.

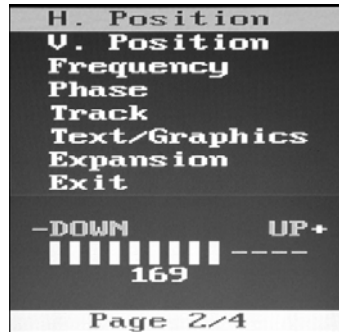

Horizontal Position

- Pressing + moves the display image to the right; Pressing – moves the display image to the left.

Vertical Position

- Pressing + moves the display image upward; Pressing – moves the display image downward.

Frequency

This item is used to decrease the vertical interference.

- 1 Select one display pattern from your computer.
- 2 Use + and – buttons on the LCD monitor to decrease the vertical interference to get the optimal display.

Phase

This item is used to decrease the horizontal interference.

- 1 Select one display pattern from your computer.
- 2 Use + and – buttons on the LCD monitor to decrease the horizontal interference to get the optimal display.

Track

Adjust the track using + and – buttons.

Text/Graphics

Select “Text” or “Graphics” display in special mode.

Expansion

- Select “Expansion” to make the image in full screen display when the resolution is lower than 800 x 600.

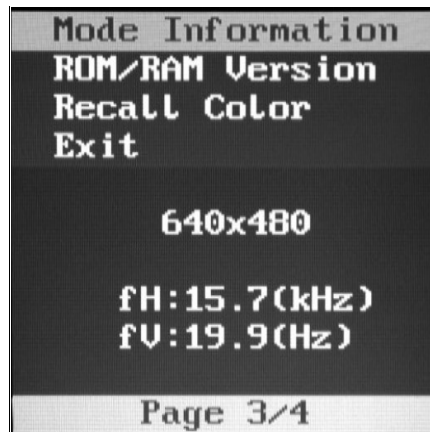

- **Mode Information**
- OSD will show the current display mode (resolution, vertical frequency and horizontal frequency) on the menu.

ROM/RAM Version

- OSD will show the current ROM / RAM VERSION (resolution, vertical frequency and horizontal frequency) on the menu.

Recall Color

- Pressing + or – buttons to recall color preset values.

Power LED Display & Power Saving

General Power Saving Mode

When the power switch are switch **on**, this LED lights in **green**.

The LED indicates the different power status with altered LED colors when monitor operates in different modes (see following table).

Mode	Power LED Color	Power Consumption	H. / V. Sync.
On	Green	25W	On
Off	Orange	<8W	Off

We recommend switching the monitor off when it is not in use for a long time.

Display Angle

For viewing clarity, you can tilt the LCD forward (up to -5 degrees) or backward (up to 60 degrees.)

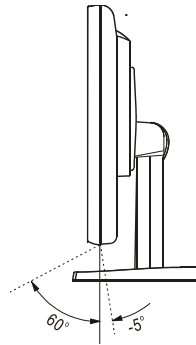

CAUTION In order to protect the LCD, be sure to hold the base when adjusting the LCD, and take care **not** to touch the screen.

TROUBLESHOOTING

If you are experiencing trouble with your touchmonitor, refer to the following table. If the problem persists, please contact your local dealer or our service center.

Solutions to Common Problems

Problem	Suggestion(s)
The monitor does not respond after you turn on the system.	<p>Check that the monitor's Power Switch is on.</p> <p>Turn off the power and check the monitor's power cord and signal cable for proper connection.</p>
Characters on the screen are dim	Refer to the <i>Controls and Adjustments</i> section to adjust the brightness.
The screen is blank	<p>During operation, the monitor screen may automatically turn off as a result of the Power Saving feature. Press any key to see if the screen reappears.</p> <p>Refer to the <i>Controls and Adjustments</i> section to adjust the brightness.</p>
Screen flashes when initialized	Turn the monitor off then turn it on again.
"Out of Range" display	<p>check to see of the resolution of your computer is higher than that of the LCD display.</p> <p>Reconfigure the resolution of your computer to make it less than or equal to 800x600. See Appendix A for more information on resolution.</p>
Touch doesn't work	Make sure cable is securely attached at both ends.



NATIVE RESOLUTION

The native resolution of a monitor is the resolution level at which the LCD panel is designed to perform best. For the Elo LCD touchmonitor, the native resolution is 800 x 600 for the 12.1 inch size. In almost all cases, screen images look best when viewed at their native resolution. You can lower the resolution setting of a monitor but not increase it.

Input Video	12.1" LCD
640x480 (VGA)	Transforms input format to 800x600
800x600 (SVGA)	Displays in Native Resolution

The native resolution of an LCD is the actual number of pixels horizontally in the LCD by the number of pixels vertically in the LCD. LCD resolution is usually represented by the following symbols:

VGA	640x480
SVGA	800x600
XGA	1024x768
SXGA	1280x1024
UXGA	1600x1200

As an example, a SVGA resolution LCD panel has 800 pixels horizontally by 600 pixels vertically. Input video is also represented by the same terms. XGA input video has a format of 1024 pixels horizontally by 768 pixels vertically. When the input pixels contained in the video input format match the native resolution of the panel, there is a one to one correspondence of mapping of input video pixels to LCD pixels. As an example, the pixel in column 45 and row 26 of the input video is in column 45 and row 26 of the LCD. For the case when the input video is at a lower resolution than the native resolution of the LCD, the direct correspondence between the video pixels and the LCD pixels is lost. The LCD controller can compute the correspondence between video pixels and LCD pixels using algorithms contained on its controller. The accuracy of the algorithms determines the fidelity of conversion of video pixels to LCD pixels. Poor fidelity conversion can result in artifacts in the LCD displayed image such as varying width characters.

B

TOUCHMONITOR SAFETY

This manual contains information that is important for the proper setup and maintenance of your touchmonitor. Before setting up and powering on your new touchmonitor, read through this manual, especially Chapter 2 (Installation), and Chapter 3 (Operation).

- 1** To reduce the risk of electric shock, follow all safety notices and never open the touchmonitor case.
- 2** Turn off the product before cleaning
- 3** Your new touchmonitor is equipped with a 3-wire, grounding power cord. The power cord plug will only fit into a grounded outlet. Do not attempt to fit the plug into an outlet that has not been configured for this purpose. Do not use a damaged power cord. Use only the power cord that comes with your Elo TouchSystems Touchmonitor. Use of an unauthorized power cord may invalidate your warranty.
- 4** The slots located on the sides and top of the touchmonitor case are for ventilation. Do not block or insert anything inside the ventilation slots.
- 5** It is important that your touchmonitor remains dry. Do not pour liquid into or onto your touchmonitor. If your touchmonitor becomes wet do not attempt to repair it yourself.

Care and Handling of Your Touchmonitor

The following tips will help keep your Elo Entuitive touchmonitor functioning at the optimal level.

- To avoid risk of electric shock, do not disassemble the brick supply or display unit cabinet. The unit is not user serviceable. Remember to unplug the display unit from the power outlet before cleaning.
- Do not use alcohol (methyl, ethyl or isopropyl) or any strong dissolvent. Do not use thinner or benzene, abrasive cleaners or compressed air.
- To clean the display unit cabinet, use a cloth lightly dampened with a mild detergent.
- Avoid getting liquids inside your touchmonitor. If liquid does get inside, have a qualified service technician check it before you power it on again.
- Do not wipe the screen with a cloth or sponge that could scratch the surface.
- To clean the touchscreen, use window or glass cleaner. Put the cleaner on the rag and wipe the touchscreen. *Never* apply the cleaner directly on the touchscreen



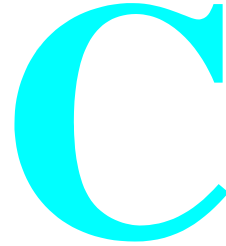

TECHNICAL SPECIFICATIONS

Display Modes

Your Elo Entuitive touchmonitor is compatible with the following standard video modes:

Item	Resolution	Type	H. Scan(KHz)	V. Scan(Hz)	Pol.
1	640X350	VGA	31.469	70.087	+ / -
2	640X350	VESA85	37.861	85.080	+ / -
3	720X400	VGA	31.469	70.087	- / +
4	720X400	VESA85	37.927	85.039	- / +
5	640X480	VGA	31.469	59.940	- / -
6	640X480	VESA72	37.861	72.809	- / -
7	640X480	VESA75	37.500	75.000	- / -
8	640X480	VESA85	43.269	85.008	- / -
9	800X600	SVGA	35.156	56.250	+ / +
10	800X600	SVGA	37.879	60.317	+ / +
11	800X600	VESA72	48.077	72.188	+ / +
12	800X600	VESA75	46.875	75.000	+ / +
13	800X600	SVGA	53.674	85.061	+ / +

Touchmonitor Specifications

Model		ET1224L
LCD Display		12.1" TFT Active Matrix Panel
Display Size		246(H) x 184.5(V) mm
Pixel Pitch		0.3075(H) x 0.3075(V) mm
Display Mode		VGA 640 x 350 (70 / 85Hz) VGA 720 x 400 (70 / 85Hz) VGA 640 x 480 (60 / 72 / 75 / 85Hz) SVGA 800 x 600 (56 / 60 / 72 / 75Hz)
Max. Resolution		SVGA 800 x 600
Contrast Ratio		150 : 1 (typical)
Brightness		180 Cd/m ² wo/touch 156 Cd/m ² w/touch
Response Time		30 ms (min.) / 100 ms (max.)
Display Color		262K
Viewing Angle		+45° ~ -45° (L/R), +30° ~ -10° (U/D) (typical)
Input Signal	Video	R.G.B. Analog 0.7V _{peak to peak}
	Sync	TTL Positive or Negative
Signal Connector		15 Pin Mini D-Sub
Front Control		Power on / off with LED, Menu / Select (up, down), Adjustment (+, -) Brightness, Contrast, Contrast, RGB Contrast, Saturation, Hue, Auto Setup, H/V-Position, Frequency, Phase, Track, Text/Graphics, Expansion, Mode Inf., Rom/Ram Ver., Recall
OSD		
Plug & Play		DDC1 / 2B
Touch Panel (optional)		AccuTouch
Power Adapter		Input AC 100-240V, 50-60Hz, Output DC 12V/2.5A (max.)
Operating Conditions	Temperature	5°C ~ 35°C (41°F ~ 95°F)
	Humidity	20% ~ 80% (No Condensation)
	Altitude	To 10,000 Feet
Storage Conditions	Temperature	-20°C ~ 60°C (-4°F ~ 140°F)
	Humidity	10% ~ 90% (No Condensation)
Dimensions (HxWxD)		310 x 312 x 146mm
Weight (Net)		3.3Kg
Certifications		UL, C-UL, FCC-B, CE

AccuTouch Touchscreen Specifications

Mechanical

Construction

Top: Polyester with outside hard-surface coating with clear or antiglare finish.

Inside: Transparent conductive coating.

Bottom: Glass substrate with uniform resistive coating. Top and bottom layers separated by Elo-patented separator dots.

Positional Accuracy

Standard deviation of error is less than 0.080 in. (2.03 mm). This equates to less than $\pm 1\%$.

Touchpoint Density

More than 100,000 touchpoints/in² (15,500 touchpoints/cm²).

Touch Activation Force

Typically less than 4 ounces (113 grams).

Surface Durability

Meets Taber Abrasion Test (ASTM D1044), CS-10F wheel, 500 g.
Meets pencil hardness 3H.

Expected Life Performance

AccuTouch technology has been operationally tested to greater than 35 million touches in one location without failure, using a stylus similar to a finger.

Optical

Light Transmission (per ASTM D1003)

Typically 85% at 550-nm wavelength (visible light spectrum).

Visual Resolution

All measurements made using USAF 1951 Resolution Chart, under 30 X magnification, with test unit located approximately 1.5 in. (38 mm) from surface of resolution chart.

Antiglare surface: 6:1 minimum.

Haze (per ASTM D1003)

Antiglare surface: Less than 15%.

Gloss (per ASTM D2457)

Antiglare surface: 90 ± 20 gloss units tested on a hard-coated front surface.

12.1" LCD Touchmonitor (ET12-XXWC-1) Dimensions

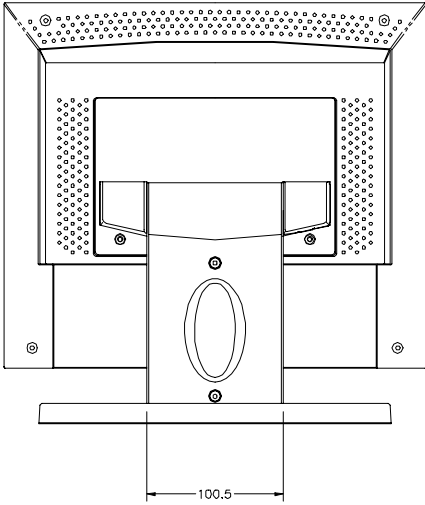
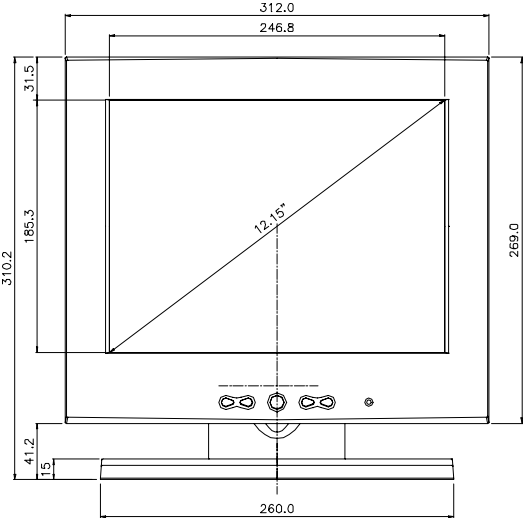

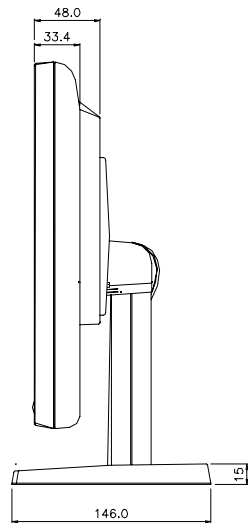

REGULATORY INFORMATION

I. Electrical Safety Information:

A) Compliance is required with respect to the voltage, frequency, and current requirements indicated on the manufacturer's label. Connection to a different power source than those specified herein will likely result in improper operation, damage to the equipment or pose a fire hazard if the limitations are not followed.

B) There are no operator serviceable parts inside this equipment. There are hazardous voltages generated by this equipment which constitute a safety hazard. Service should be provided only by a qualified service technician.

C) This equipment is provided with a detachable power cord which has an integral safety ground wire intended for connection to a grounded safety outlet.

1) Do not substitute the cord with other than the provided approved type. Under no circumstances use an adapter plug to connect to a 2-wire outlet as this will defeat the continuity of the grounding wire.

2) The equipment requires the use of the ground wire as a part of the safety certification, modification or misuse can provide a shock hazard that can result in serious injury or death.

3) Contact a qualified electrician or the manufacturer if there are questions about the installation prior to connecting the equipment to mains power.

II. Emissions and Immunity Information

A) Notice to Users in the United States: This equipment has been tested and found to comply with the limits for a Class B digital device, pursuant to Part 15 of FCC Rules. These limits are designed to provide reasonable protection against harmful interference in a residential installation. This equipment generates, uses, and can radiate radio frequency energy, and if not installed and used in accordance with the instructions, may cause harmful interference to radio communications.

B) Notice to Users in Canada: This equipment complies with the Class B limits for radio noise emissions from digital apparatus as established by the Radio Interference Regulations of Industrie Canada.

C) Notice to Users in the European Union: Use only the provided power cords and interconnecting cabling provided with the equipment. Substitution of provided cords and cabling may compromise electrical safety or CE Mark Certification for emissions or immunity as required by the following standards:

This Information Technology Equipment (ITE) is required to have a CE Mark on the manufacturer's label which means that the equipment has been tested to the following Directives and Standards:

This equipment has been tested to the requirements for the CE Mark as required by EMC Directive 89/336/EEC indicated in European Standard EN 55 022 Class B and the Low Voltage Directive 73/23/EEC as indicated in European Standard EN 60 950.

D) General Information to all Users: This equipment generates, uses and can radiate radio frequency energy. If not installed and used according to this manual the equipment may cause interference with radio and television communications. There is, however, no guarantee that interference will not occur in any particular installation due to site-specific factors.

1) In order to meet emission and immunity requirements, the user must observe the following:

- a) Use only the provided I/O cables to connect this digital device with any computer.
- b) To ensure compliance, use only the provided manufacturer's approved line cord.
- c) The user is cautioned that changes or modifications to the equipment not expressly approved by the party responsible for compliance could void the user's authority to operate the equipment.

2) If this equipment appears to cause interference with radio or television reception, or any other device:

- a) Verify as an emission source by turning the equipment off and on.
- b) If you determine that this equipment is causing the interference, try to correct the interference by using one or more of the following measures:
 - i) Move the digital device away from the affected receiver.
 - ii) Reposition (turn) the digital device with respect to the affected receiver.
 - iii) Reorient the affected receiver's antenna.
 - iv) Plug the digital device into a different AC outlet so the digital device and the receiver are on different branch circuits.
 - v) Disconnect and remove any I/O cables that the digital device does not use. (Unterminated I/O cables are a potential source of high RF emission levels.)
 - vi) Plug the digital device into only a grounded outlet receptacle. Do not use AC adapter plugs. (Removing or cutting the line cord ground may increase RF emission levels and may also present a lethal shock hazard to the user.)

If you need additional help, consult your dealer, manufacturer, or an experienced radio or television technician.



FC Tested To Comply
With FCC Standards
FOR HOME OR OFFICE USE

WARRANTY

Except as otherwise stated herein or in an order acknowledgment delivered to Buyer, Seller warrants to Buyer that the Product shall be free of defects in materials and workmanship. The warranty for the touchmonitors and components of the product are: 1 year monitor, 5 years Accu- Touch screen, 5 years Controller.

Seller makes no warranty regarding the model life of components. Seller's suppliers may at any time and from time to time make changes in the components delivered as Products or components.

Buyer shall notify Seller in writing promptly (and in no case later than thirty (30) days after discovery) of the failure of any Product to conform to the warranty set forth above; shall describe in commercially reasonable detail in such notice the symptoms associated with such failure; and shall provide to Seller the opportunity to inspect such Products as installed, if possible. The notice must be received by Seller during the Warranty Period for such product, unless otherwise directed in writing by the Seller. Within thirty (30) days after submitting such notice, Buyer shall package the allegedly defective Product in its original shipping carton(s) or a functional equivalent and shall ship to Seller at Buyer's expense and risk.

Within a reasonable time after receipt of the allegedly defective Product and verification by Seller that the Product fails to meet the warranty set forth above, Seller shall correct such failure by, at Seller's options, either (i) modifying or repairing the Product or (ii) replacing the Product. Such modification, repair, or replacement and the return shipment of the Product with minimum insurance to Buyer shall be at Seller's expense. Buyer shall bear the risk of loss or damage in transit, and may insure the Product. Buyer shall reimburse Seller for transportation cost incurred for Product returned but not found by Seller to be defective. Modification or repair, of Products may, at Seller's option, take place either at Seller's facilities or at Buyer's premises. If Seller is unable to modify, repair, or replace a Product to conform to the warranty set forth above, then Seller shall, at Seller's option, either refund to Buyer or credit to Buyer's account the purchase price of the Product less depreciation calculated on a straight-line basis over Seller's stated Warranty Period.

THESE REMEDIES SHALL BE THE BUYER'S EXCLUSIVE REMEDIES FOR BREACH OF WARRANTY. EXCEPT FOR THE EXPRESS WARRANTY SET FORTH ABOVE, SELLER GRANTS NO OTHER WARRANTIES, EXPRESS OR IMPLIED BY STATUTE OR OTHERWISE, REGARDING THE PRODUCTS, THEIR FITNESS FOR ANY PURPOSE, THEIR QUALITY, THEIR MERCHANTABILITY, THEIR NONINFRINGEMENT, OR OTHERWISE. NO EMPLOYEE OF SELLER OR ANY OTHER PARTY IS AUTHORIZED TO MAKE ANY WARRANTY FOR THE GOODS OTHER THAN THE WARRANTY SET FORTH HEREIN. SELLER'S LIABILITY UNDER THE WARRANTY SHALL BE LIMITED TO A REFUND OF THE PURCHASE PRICE OF THE PRODUCT. IN NO EVENT SHALL SELLER BE LIABLE FOR THE COST OF PROCUREMENT OR INSTALLATION OF SUBSTITUTE GOODS BY BUYER OR FOR ANY SPECIAL, CONSEQUENTIAL, INDIRECT, OR INCIDENTAL DAMAGES.

Buyer assumes the risk and agrees to indemnify Seller against and hold Seller harmless from all liability relating to (i) assessing the suitability for Buyer's intended use of the Products and of any system design or drawing and (ii) determining the compliance of Buyer's use of the Products with applicable laws, regulations, codes, and standards. Buyer retains and accepts full responsibility for all warranty and other claims relating to or arising from Buyer's products, which include or incorporate Products or components manufactured or supplied by Seller. Buyer is solely responsible for any and all representations and warranties regarding the Products made or authorized by Buyer. Buyer will indemnify Seller and hold Seller harmless from any liability, claims, loss, cost, or expenses (including reasonable attorney's fees) attributable to Buyer's products or representations or warranties concerning same.



INDEX



Numerics

12.1" LCD Touchmonitor (ET12-XXWC-1) Dimensions, 26

A

About the Product, 2
About Touchmonitor Adjustments, 9
AccuTouch Touchmonitor Specifications, 25
Auto Setup, 13

B

Brightness, 13

C

Care and Handling of Your Touchmonitor, 22
Cleaning Your Touchmonitor, 22
Construction, AccuTouch, 25
Contrast/Red, Green, Blue, 13
Controls and Adjustment, 12

D

Display Angle, 16
Display Modes, 23

E

Electrical Safety Information, 29
Emissions and Immunity Information, 29
Expansion, 15
Expected Life Performance, AccuTouch, 25

F

Frequency, 14

G

General Power Saving Mode, 15
Gloss, AccuTouch, 25

H

Haze, AccuTouch, 25
Horizontal Position, 14
Hue, 13

I

Image problem, 17
Image, scrolling, 17

Installation and Setup, 3
Installing the Driver Software, 6
Installing the Serial Touch Driver, 7
Installing the Serial Touch Driver for MS-DOS and Windows 3.1, 8
Installing the Serial Touch Driver for Windows 2000, Me, 95/98 and NT 4.0, 7

L

Light Transmission, AccuTouch, 25

M

Mechanical, AccuTouch, 25
Mode Information, 15

N

Native Resolution, 19

O

Optical, AccuTouch, 25
OSD Control Options, 13
OSD Menu Functions, 12

P

Phase, 14
Positional Accuracy, AccuTouch, 25
Power LED Display & Power Saving, 15
Precautions, 1
Product Description, 1

R

Recall Color, 15
Regulatory Information, 29
ROM/RAM Version, 15

S

Saturation, 13
Solutions to Common Problems, 17
Surface Durability, AccuTouch, 25
SVGA, 19
SXGA, 19

T

Technical Specifications, 23
Text/Graphics, 14

Touch Activation Force, AccuTouch, 25
Touch not working, 17
Touchmonitor Safety, 21
Touchmonitor Specifications, 24
Touchpoint Density, AccuTouch, 25
Track, 14
Troubleshooting, 17

U

Unpacking Your Touchmonitor, 3
UXGA, 19

V

Vertical Position, 14
VGA, 19
Visual Resolution, AccuTouch, 25

W

Warranty, 33

X

XGA, 19